

Arms

C15

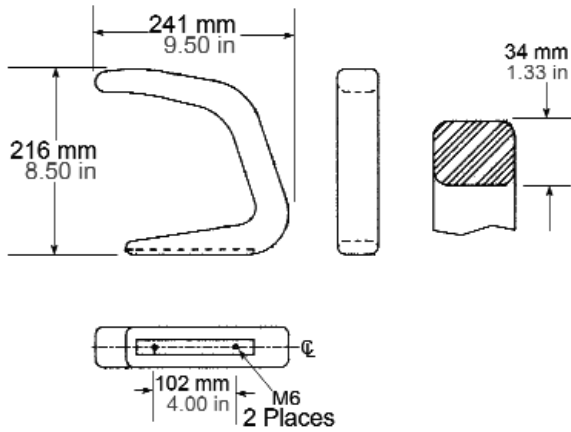

Product No. 30-91

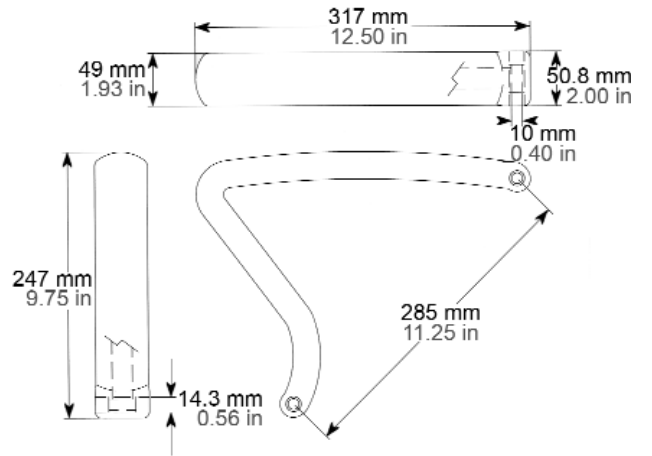

Product No. 30-92



Product No. 30-21

